



ALIZEO

BRANCARD DE TRANSFERT À HAUTEUR VARIABLE
VARIABLE HEIGHT TRANSFER STRETCHER



L'exigence de la fiabilité pour un usage intensif
Reliability for intensive use

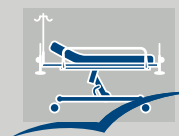



Position basse
Low position



Transfert
Transfer



Proclive
Reverse trendelenburg



Déclive
Trendelenburg



Position haute
High position



Capacité / Capacity
250 KG
Modèles hydrauliques
Hydraulic models

Modèle bi-plan présenté avec options
2 section model shown with options

Conçu pour un usage intensif - Designed for intensive use

La structure renforcée du brancard permet une **capacité de charge de 250 kg pour les modèles hydrauliques** et 200 kg pour les modèles électriques. Le brancard est radio transparent sur toute la longueur. L'utilisation de l'option cassette radio (format maxi 46cm x 46cm) est facilitée par son chargement latéral. Le brancard est équipé de **matériaux de haute qualité** ainsi que des **visseries en inox** pour une plus grande longévité.

The reinforced structure of the stretcher allows a **patient weight capacity of 250kg for hydraulic models** and 200kg for electric models. The stretcher has a full length radio-transparent surface. Use of the optional X-ray cassette holder (maxi format 46cm x 46cm) is facilitated due to its side loading and accommodates all standard size x-ray cassettes. The stretcher is equipped with **high quality materials** and **stainless steel screws** for a long life span.



Poignées repliables
Pop-up push handles



Commandes bilatérales
Bilateral control

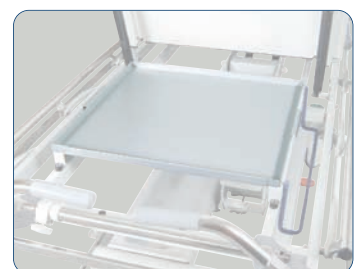

Support cassette
Cassette holder



MODÈLES HYDRAULIQUES 250 kg HYDRAULIC MODELS 250kg

Bi plan – Longueur 190 cm 2 Section platform – length 190cm.....	21245-10
Bi plan – Longueur 205 cm 2 Section platform – length 205cm.....	21745-10
Plicature 4 plans – Longueur 190 cm 4 Section platform with Knee Flex capacity – length 190cm.....	21245-20
Plicature 4 plans – Longueur 205 cm 4 Section platform with Knee Flex capacity – length 205cm.....	21745-20

MODÈLES ÉLECTRIQUES 200 kg ELECTRIC MODELS 200kg

Bi plan – Longueur 190 cm 2 Section platform – length 190cm.....	21265-10
Bi plan – Longueur 205 cm 2 Section platform – length 205cm.....	21765-10
Plicature 4 plans – Longueur 190 cm 4 Section platform with Knee Flex capacity – length 190cm.....	21265-20
Plicature 4 plans – Longueur 205 cm 4 Section platform with Knee Flex capacity – length 205cm.....	21765-20

CARACTÉRISTIQUES STANDARD STANDARD FEATURES

Hauteur variable hydraulique ou électrique de 64 à 98 cm (matelas compris)
Hydraulic or electric height adjustment from 64 to 98cm (mattress included)

Proclive/Déclive par vérin à gaz (côté pied)
Gas-spring assisted Trendelenburg (foot end)

Structure acier revêtement époxy polyester gris
Grey epoxy polyester coated steel frame

Plan dur en résine radio transparent
Radio transparent resin hard top

Matelas amovible soudé anti-feu M1, housse vinyl bleu marine
Removable seamless flame-retardant M1 mattress, navy blue vinyl covering

4 roues ø 200 mm avec freinage centralisé, dont 2 directionnelles côté tête
(contrôle pédale aux 4 coins)
4 castors ø 200 with central blocking system, 2 directional head end
(pedal control at each corner)

Dossier relevable par double vérin à gaz
Gas-spring assisted backrest

Tige porte sérum télescopique repliable [2 crochets] - mini 62, maxi 129 cm
Folding telescopic IV pole (2 hooks) - mini 62, maxi 129cm

4 amortisseurs de chocs
4 shock absorbers

4 supports accessoires
4 accessory holders

Barrières repliables sous le niveau de couchage
Folding side rails

Poignée cale pied rabattable
Folding foot-end pushbar

Poignées côté tête repliables
Integrated pop-up push handles

Paire de rails 25/10
Pair of rails 25/10

Poids maximum du patient autorisé 250 kg pour les modèles hydrauliques
et 200 kg pour les modèles électriques (testé en statique à 800 kg)
250kg patient weight capacity for hydraulic models and 200kg for electric models
(tested at a static of 800 kg)



Porte-sérum repliable
Folding IV pole



Poignée rabattable
Folding pushbar

ACCESSOIRES - ACCESSORIES

25510-10

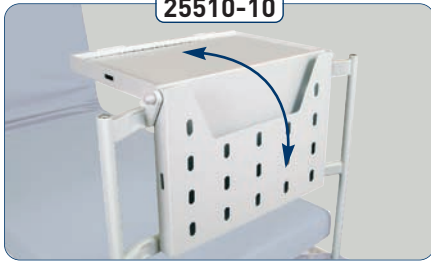

Support moniteur et documents
Monitor & document support

23540-01

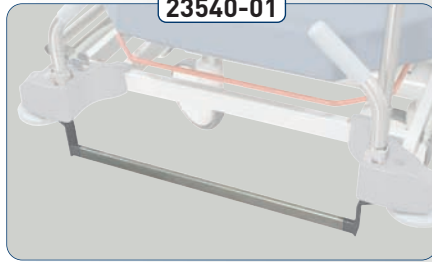

Rail côté tête
Head end rail

2536



Appui-bras
Arm rest

23530



Tablette repas
Meal Tray

25155-10

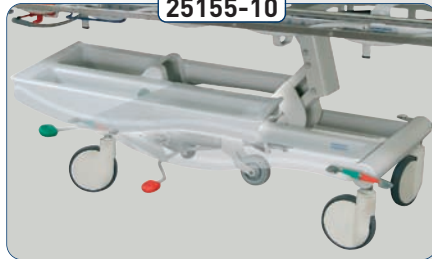

Carter amovible porte-bouteille oxygène (dim. D, E, F)
Removable oxygen bottle holder base (dim. D, E, F)

25118-10



Support cassette
Cassette holder

22296-01



Tige potence porte-sérum
Rotating IV Pole

25157-01

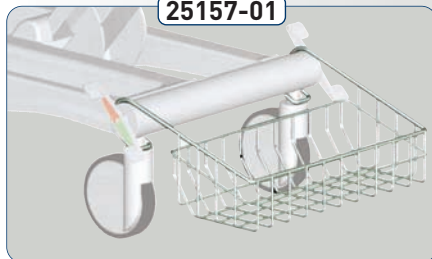

Panier frontal (dimensions utiles 608x250x170 mm)
Front basket (608x250x170mm)

25156-01

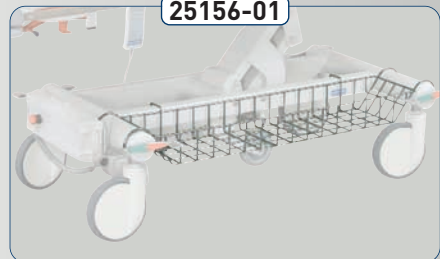

Panier latéral (dimensions utiles 900x165x100 mm)
Lateral basket (900x165x100mm)

23560-01



Support poche urine avec ancrage
Urine bag support

23560-01 + 45080



Porte bocal
Bowl holder with support

878-12



Etau coulissant pour rail 25 x 10
Sliding clamp for 25 x 10 rail

25190-50



Matelas cousu
Sewed mattress

23620



Transformateur pour chargeur batterie
Transformer for battery charger

23621



Station fixe pour recharge batterie
Fixed battery recharging station

23622



Batterie supplémentaire
Additional battery

OPTIONS

25139-10



5^e roue directionnelle
5th steering castor

25161-10

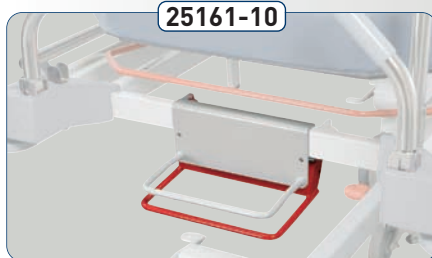

Proctive / décline côté tête
Head-end reverse trendelenburg / trendelenburg

25190-90



Matelas cousu à la place du matelas standard
Sewed mattress instead of standard mattress

Hygiène Totale – Total Hygiene

Le brancard est conçu pour un nettoyage rapide et facile avec son matelas et carter amovible. Le matelas anti-allergique est **imperméable et entièrement soudé** minimisant le risque d'infection.

*The stretcher is designed to facilitate cleaning with its removable mattress and ABS base. The anti-allergenic mattress is **waterproof and fully welded** minimising the risk of cross infection.*

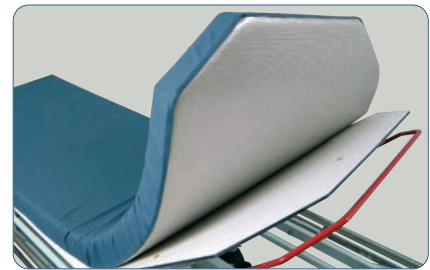

Matelas amovible soudé avec surface anti-glisse
Removable welded mattress with non-slip surface



Mousse viscoélastique (2 cm) et haute densité (6 cm)
Viscoelastic (2cm) & high density (6cm) foam

Confort du Patient – Patient Comfort

Le matelas Promotal est composé de 6 cm de mousse haute densité qui favorise le confort du patient et 2 cm de mousse viscoélastique pour une meilleure répartition de la pression du corps. Le modèle avec plicature permet de placer le patient dans différentes positions pour accentuer son confort.

The Promotal mattress is composed of a double layer of foam: 6cm of high density foam that enhances patient comfort and 2cm of visco-elastic foam that offers optimal compression distribution of the body. The 4 section knee-flex model allows to place patients in several positions for optimized comfort.



Modèle plicature 4 plans présenté avec options
4 section Knee-flex model with options

DIMENSIONS (mm)

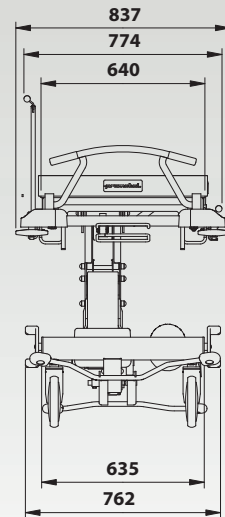
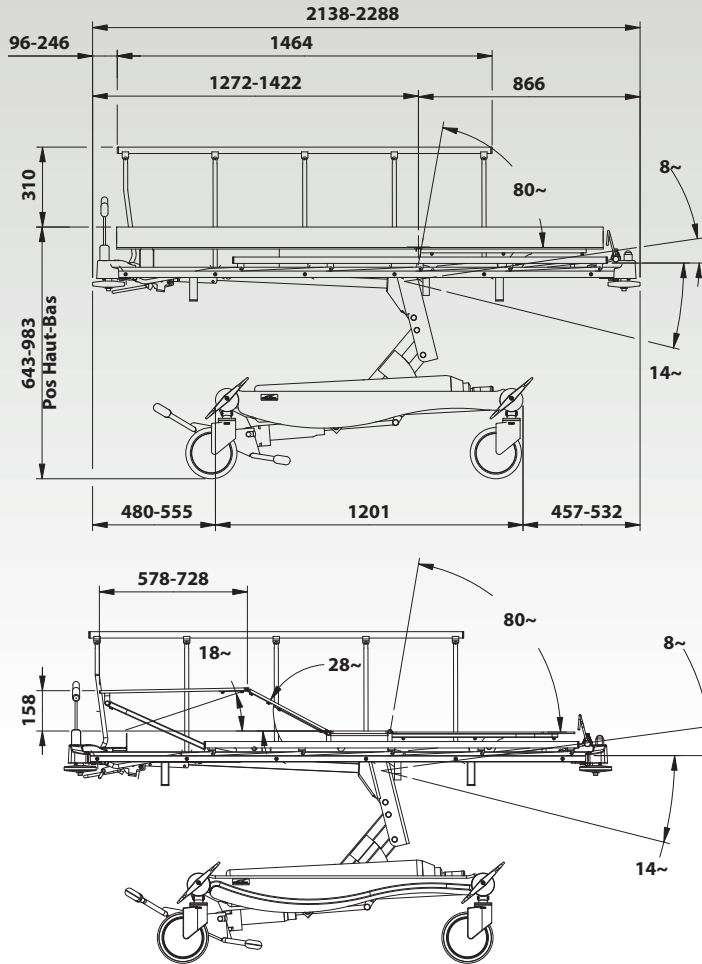

POIDS - VOLUME / WEIGHT - VOLUME

	Net	Brut	Volume
190 cm	122 kg	170 kg	1,45 m ³
190 cm (4 section/plan)	136 kg	184 kg	1,45 m ³
205 cm	126 kg	178 kg	1,55 m ³
205 cm (4 section/plan)	140 kg	192 kg	1,55 m ³

CHOIX DES COULEURS DE MATELAS CHOICE OF MATTRESS COLORS

Matelas soudé standard : 1 couleur (bleu) – Standard welded mattress only in blue

Matelas cousu : 3 couleurs au choix* – Sewed mattress: 3 colours in choice*



ÉTAIN

MARINE

OBSCURE

* Pour une autre couleur, nous consulter / For another color, contact us

SURFACE RADIO-TRANSPARENT X-RAY SURFACE (mm)

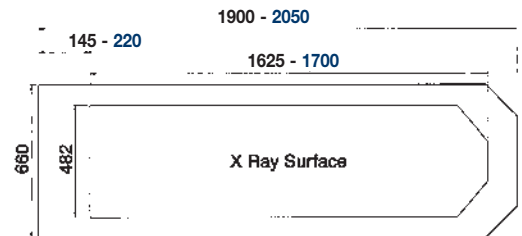

MOBILIER HOSPITALIER PROMOTAL PROMOTAL HOSPITAL FURNITURE

